

Burlington®

Welcome to the Bathroom Brands Technical Whitebook



[Home](#) > [Whitebook](#) > [Radiators](#) > Trafalgar radiator

Trafalgar radiator



As Shown

R1 CHR Trafalgar radiator

shown with the summer heating kit

Colour

R1 CHR - radiator - chrome

Material

R1 CHR - radiator - steel

Size

R1 CHR - 235 x 642 x 950mm

Nett Weight

R1 CHR - radiator - 16.58kg

Gross Weight Including Packaging

R1 CHR - radiator - 17.58kg

Packed Dimension

R1 CHR - 980 x 670 x 130 = 0.0854 m³

Guarantee

5 year guarantee*

[*Full terms & conditions here](#)

Standards Information

R1 CHR - WRAS Not Applicable

BS EN 442-1:2015

BS EN 442-2:2015

BS EN 248:2002

Product Options

Radiator Options



[White & Chrome](#)



[Black & Chrome](#)



[White & Nickel](#)

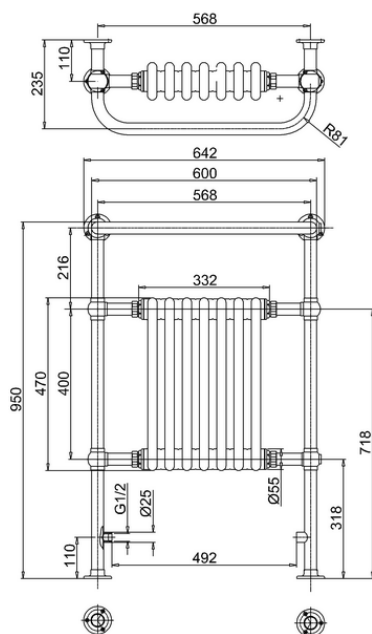

Additional Information

for technical information on the summer heating kit please refer to the summer heating kit section

Diameter of tubes is 32mm.

Output:2346 BTUs/558 watts ($\Delta T=50^{\circ}C$)

Distance from wall to the rail is 110mm.

Fill the radiator approximately 90% (6.5) with an anti-rust mixture if the radiator is to be used for electric heating only (not connected to a central heating system)

Includes all brackets and fixings.

High quality chrome plated finish.

Valves are required. These are not included.

Designed to be plumbed into your central heating system.

Operating pressure up to 8 bar.(Certified by BEN N.L.)

Maximum working temperature:95°C

420mm plumbing pipe centers

Compatible Products

































R10 CHR - 400W Summer electric heating kit for Trafalgar

R6 CHR - Angled radiator valves chrome

[Spare parts \(click to display spare parts for this product\)](#)



Downloads

 Instructions - PDF - R1 CHR (English)	
 Instructions - PDF - R1 CHR (French)	
 2D CAD-File - DWG - R1 CHR	
 2D Drawing - PDF - R1 CHR	
 3D DWG - File - DWG - R1 CHR	
 3D DXF - File - DXF - R1 CHR	
 3D IGS - File - IGS - R1 CHR	
 3D RFA BIMM Objects - File - RFA - R1 CHR	
 Lifestyle image 1 - 	jpg  tiff 
 Lifestyle image 2 - 	jpg  tiff 
 Lifestyle image 3 - 	jpg  tiff 
 Cutout image 1 - 	jpg  tiff 

* Please note that some of the drawings might not be drawn to scale. Please refer to actual dimensions marked on the drawings.