

Burlington®

Welcome to the Bathroom Brands Technical Whitebook



[Home](#) > [Whitebook](#) > [Ceramic WC](#) > [Back to Wall](#) > Arcade back-to-wall pan

Arcade back-to-wall pan



As Shown

ARC6 Arcade back to wall pan
ARCS45 NKL Arcade White seat soft close - nickel
ARCA51 NKL Set of 2 handles with screws & template for Arcade

Colour

ARC6 - pan - white
ARCA51 NKL - handles - nickel plated
ARCS45 NKL - seat - white

Material

ARC6 - pan - vitreous china
ARCA51 NKL - handles - brass
ARCS45 NKL - seat - compress wood particle with a solid wood veneer

Size

ARC6 - 518 x 365 x 460mm
ARCA51 NKL - 56 x 50 x 8mm

Nett Weight

ARC6 - pan - 25.5kg
ARCA51 NKL - handles - 0.04kg
ARCS45 NKL - seat - 3.9kg

Gross Weight Including Packaging

ARC6 - pan - 27.35kg
ARCA51 NKL - handles - 0.12kg
ARCS45 NKL - seat - 4.2kg

Packed Dimension

ARC6 - 543 x 390 x 490 = 0.1038 m3
ARCA51 NKL - 60 x 60 x 100 = 0.0004 m3
ARCS45 NKL - 385 x 75 x 460 = 0.0133 m3

Guarantee

Lifetime guarantee*

[*Full terms & conditions here](#)

Standards Information

ARC6 - WRAS Not Applicable
ARCA51 NKL - WRAS Not Applicable
ARCS45 NKL - WRAS Not Applicable
BS EN 997:2018
BS EN 33:2019

Additional Information

Supplied with floor fixings

[Spare parts \(click to display spare parts for this product\)](#)

Downloads

Instructions - PDF - ARCS45 NKL (English)



Product Options

finish options









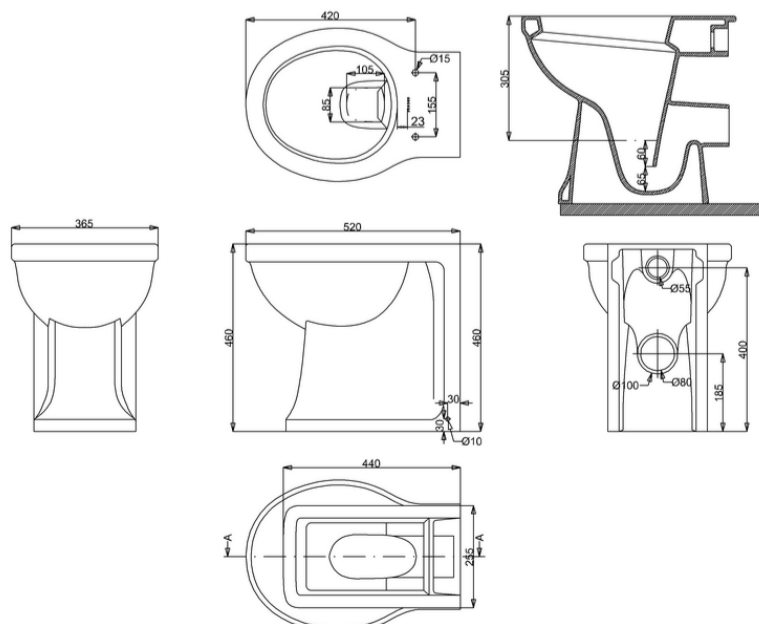













chrome



nickel



-  Instructions - PDF - ARCA51 NKL (English) 
-  Instructions - PDF - ARCS45 NKL (French) 
-  Instructions - PDF - ARCA51 NKL (French) 
-  2D CAD-File - DWG - ARC6 NKL 
-  2D Drawing - PDF - ARC6 NKL 
-  3D DWG - File - DWG - ARC6 NKL 
-  3D DXF - File - DXF - ARC6 NKL 
-  3D IGS - File - IGS - ARC6 NKL 
-  3D RFA BIMM Objects - File - RFA - ARC6 NKL 
-  Cutout image 1 -  jpg 

* Please note that some of the drawings might not be drawn to scale. Please refer to actual dimensions marked on the drawings.