

# Burlington®

## Welcome to the Bathroom Brands Technical Whitebook



[Home](#) > [Whitebook](#) > [Basins](#) > [Natural Stone](#) > Small 55cm basin

### Small 55cm basin



#### As Shown

EB7E Roll top basin with overflow  
B7ES Roll top basin stand

#### Colour

B7ES - basin stand - polished  
EB7E - basin - white

#### Material

B7ES - basin stand - stainless steel  
EB7E - basin - natural stone

#### Size

B7ES - 525 x 450 x 870mm  
EB7E - 550 x 470 x 171mm

#### Nett Weight

B7ES - basin stand - 5kg  
EB7E - basin - 11.5kg

#### Gross Weight Including Packaging

B7ES - basin stand - 5.6kg  
EB7E - basin - 13.5kg

#### Packed Dimension

B7ES - 530 x 460 x 86 = 0.021 m<sup>3</sup>  
EB7E - 600 x 520 x 200 = 0.0624 m<sup>3</sup>

#### Tap Hole Options

The basin is supplied with no tap holes. They can be drilled on site.

#### Guarantee

10 year guarantee\*

[\\*Full terms & conditions here](#)

#### Standards Information

B7ES - WRAS Not Applicable  
EB7E - WRAS Not Applicable  
BS EN 14688:2015  
BS EN 31:2011

#### Additional Information

Overflow hole is predrilled

#### Compatible Products









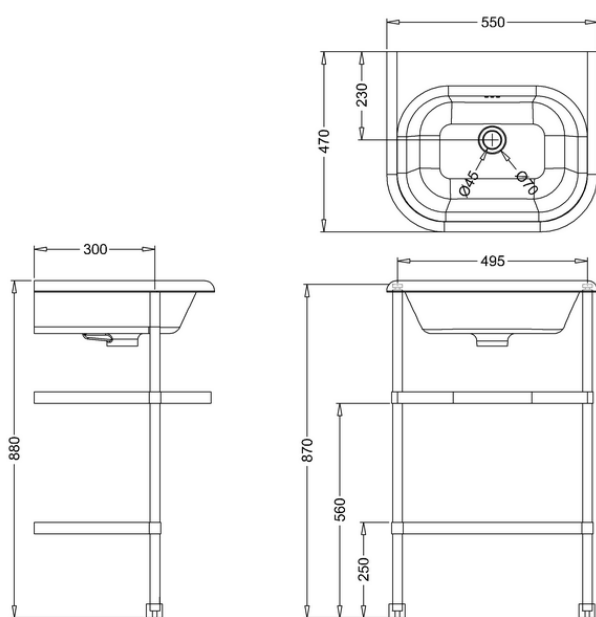















W11 - "Click-clack" Basin waste slotted  
W14 - Traditional basin bottle trap  
W18 - Flip-top basin waste slotted

[Spare parts \(click to display spare parts for this product\)](#)



#### Downloads



 Instructions - PDF - EB7E (English)	
 Instructions - PDF - B7ES (English)	
 Instructions - PDF - EB7E (French)	
 Instructions - PDF - B7ES (French)	
 2D CAD-File - DWG - EB7E B7ES	
 2D Drawing - PDF - EB7E B7ES	
 3D DWG - File - DWG - EB7E B7ES	
 3D DXF - File - DXF - EB7E B7ES	
 3D IGS - File - IGS - EB7E B7ES	
 3D RFA BIMM Objects - File - RFA - EB7E B7ES	
 Cutout image 1 - 	jpg 
 Cutout image 2 - 	pending.

\* Please note that some of the drawings might not be drawn to scale. Please refer to actual dimensions marked on the drawings.