

Metallo 114

MET-114-N-PC / MET-114-1TH-PC / MET-114-3TH-PC

Front view

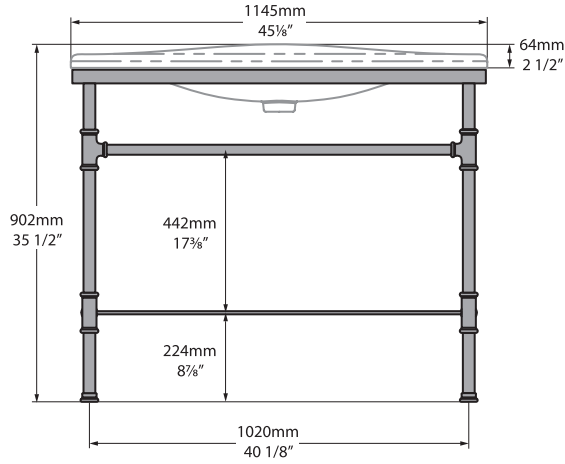

Side view

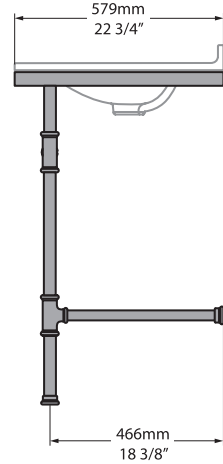

MET-114-N-PC

MET-114-1TH-PC

MET-114-3TH-PC

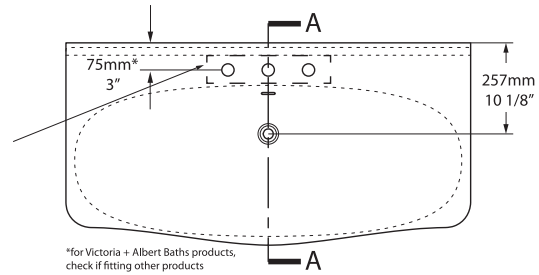
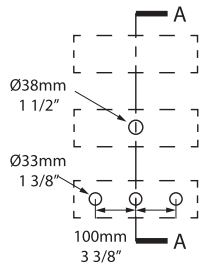

*for Victoria + Albert Baths products, check if fitting other products

Section AA

Recommended wall spout reach

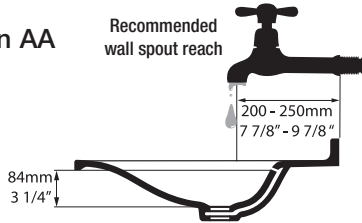

Features an internal overflow
Integrierter Überlauf
Dispose d'un trop-plein interne
Incluye el rebosadero integrado
Caratterizzato da un troppopieno interno



Tap holes can be drilled by installer
Armaturenlöcher können leicht vom Installateur gebohrt werden
Les trous de robinetterie peuvent être percés par l'installateur
Pueden ser perforados por el instalador
I fori per rubinetti possono essere perforati dall'installatore



Option to order with or without pre-drilled tap holes
Mit oder ohne Vorbohrungen für Armaturen erhältlich
Option de commande : avec ou sans trou de robinetterie
Disponibile con o sin agujeros pretaladrados para grifos
Possibilità di ordinare con o senza fori per rubinetti



BV-2.1_0011



rich in
Volcanic
Limestone™

● Polished Chrome, Chrom Poliert, Chrome Poli,
Cromado brillante, Cromo Lucidato

Recommended wastes: K-22-xx / K-24-xx / K-25-xx / K-122-xx

*All measurements subject to +/-5% tolerance



Massachusetts Code: Approved
cUPC listing by IAPMO: File No. 6970



Guaranteed for residential use for 5 years*
5 Jahre Garantie bei privater Nutzung
5 ans de garantie pour un usage domestique
Garantía de 5 años para uso domestico
La sicurezza garantita per uso residenziale per 5 anni